

Part Number: 1303231

Model Code: WP09A1B230R03GA103N

Product Capabilities

Displacement 1	230 - 23 cm. ³ /1.403 in. ³
Displacement 2	N/A
Displacement 3	N/A
Displacement 4	N/A
Max. Continuous Pressure Section 1	3200 psi/221 bar
Max. Continuous Pressure Section 2	N/A
Max. Continuous Pressure Section 3	N/A
Max. Continuous Pressure Section 4	N/A
Max. Speed Section 1	2800 rpm
Max. Speed Section 2	N/A
Max. Speed Section 3	N/A
Max. Speed Section 4	N/A
Rotation	R - Clockwise
Relief Valve Setting	Not Applicable
Flow Control Setting	NN - Not Applicable

Hydraulic schematic

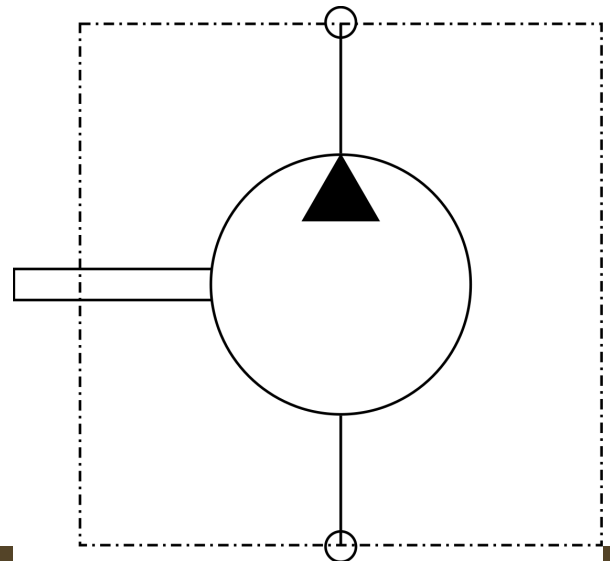

Concentric Rockford Inc.
 2222 15th Street Rockford, IL 61104
 Tel: 1-815-398-4400
www.concentricab.com
 E-mail: info.usro@concentricab.com

The information on this PDF datasheet and any associated models or drawings from the Concentric Hydraulic Product Configurator are for reference only. Concentric will not accept any responsibility for misapplications and reserves the right to modify its products without prior notice. Concentric does not accept responsibility or warranty products without prior application approval from Concentric engineering.

Fluids

Most premium grade petroleum base fluids can be used with W900 pumps. Optimum operating viscosity is 16-40 cSt (80-185 SSU). Minimum operating viscosity is 10 cSt (59 SSU) at maximum rated pressure and maximum rated speed. Maximum operating viscosity is 750 cSt (3409 SSU). Maximum cold start viscosity is 2000 cSt (9091 SSU). Contact Concentric for additional information regarding W900 performance using other fluids.

Filtration

Proper filtration is critical to the trouble free operation of any hydraulic system. For optimum pump life at maximum pressure ISO Code 18/14 filtration is recommended. A 10-micron filter sized to accommodate full system return flow is recommended for most operating environments.

Shaft Seals

If your pump has a case drain, the case drain pressure must not exceed the shaft seal ratings below. If your pump does not have a case drain, the inlet pressure must not exceed the shaft seal ratings below. Additional shaft seals are available. Contact your Concentric representative for more details.

Seal Description	Max. Pressure PSI (Bar)	
	Cont.	Inter.
Standard Buna	44 (3)	58 (4)
Standard Viton	58 (4)	73 (5)
High Pressure Viton	87 (6)	116 (8)
Arctic Viton	87 (6)	116 (8)

Operating temperature

Fluid temperature range (Mineral Oil): Max 93°C (200°F) continuous and Max. 105°C (221°F) intermittent.

Inlet Conditions

Inlet vacuum should not exceed 0.35 Bar below atmospheric pressure (10 inHg). Continuous operation at vacuums in excess of 0.2 Bar below atmospheric pressure (6 inHg) are not recommended. Refer to the shaft seal section for more details on inlet/case drain pressure maximum limits.

Shaft Loading

For all W900 pumps, it is crucial to check shaft loading. Individual section maximum pressure ratings do not necessarily reflect where the W900 pumps can operate, especially in multiple pump configurations. Use the equations below to verify if your application pressures are within shaft and coupling limits. The main drive shaft equation applies to all pumps. Four, three, and two section equations apply if you have multiple section pumps. Note if you have a four or three section pump, you will also need to verify coupling equations for multiple section pumps smaller than the one configured (i.e. for a four section check drive shaft, three, and two section calculations as well.) In multiple pumps, shaft end section must have largest displacement. Each consecutive section must have displacement equal to or smaller than section preceding. Contact Concentric Applications Engineering for more details on shaft loading restrictions.

Where for English units:

$P_{1/2/3/4}$ = Section 1/2/3/4 pressure (psi)

$V_{1/2/3/4}$ = Section 1/2/3/4 displacement (in³/rev)

For metric units:

$P_{1/2/3/4}$ = Section 1/2/3/4 pressure (bar)

$P_{1/2/3/4}$ = Section 1/2/3/4 pressure (bar)

Drive Shaft Loading Equation	Max. Permitted Value (English/Metric units)
$P_1xV_1+P_2xV_2+P_3xV_3+P_4xV_4 \leq$	8505 / 9608
Four Section Coupling Loading Equation	
$P_2xV_2+P_3xV_3+P_4xV_4 \leq$	4293 / 4849
Three Section Coupling Loading Equation	
$P_2xV_2+P_3xV_3 \leq$	4293 / 4849
Two Section Coupling Loading Equation	
$P_2xV_2 \leq$	4293 / 4849

Concentric Rockford Inc.
 2222 15th Street Rockford, IL 61104
 Tel: 1-815-398-4400
www.concentricab.com
 E-mail: info.usro@concentricab.com

The information on this PDF datasheet and any associated models or drawings from the Concentric Hydraulic Product Configurator are for reference only. Concentric will not accept any responsibility for misapplications and reserves the right to modify its products without prior notice. Concentric does not accept responsibility or warranty products without prior application approval from Concentric engineering.

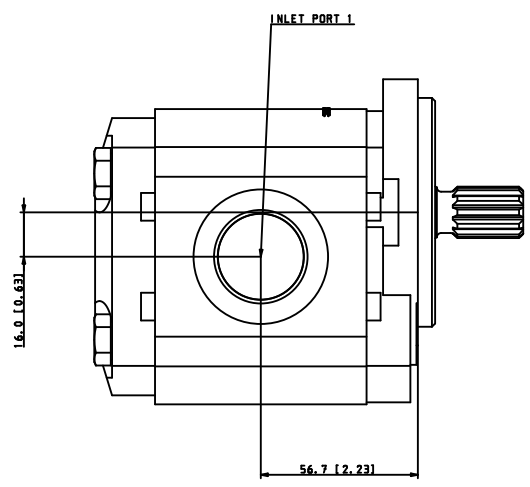
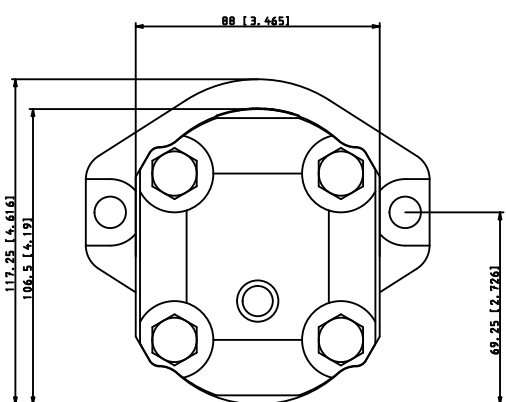
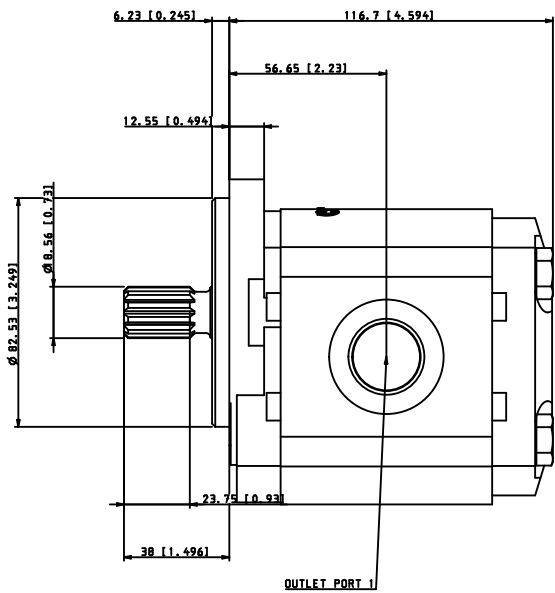
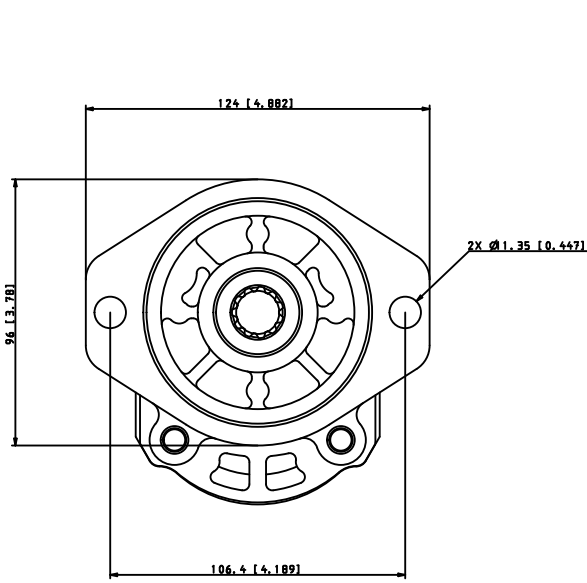

Part Number	WP09A1B230R03GA103N
Design Code	WP09A1 - Single Pump
Seal Material	B - Buna
Displacement 1	230 - 23 cm. ³ /1.403 in. ³
Displacement 2	N/A
Displacement 3	N/A
Displacement 4	N/A
Rotation	R - Clockwise
Mounting Flange	03 = SAE "A" 2-bolt
Drive Shaft	GA - SAE "A" Spline (11 Tooth)
Port 1 Standard Porting	103 - SAE Straight Thread (1-5/16-12,1-1/16-12) - Side
Port 2 Standard Porting	N/A
Port 3 Standard Porting	N/A
Port 4 Standard Porting	N/A
Valve Type Designation	NN - Not Applicable
Flow Control Setting	NN - Not Applicable
Relief Valve Setting	Not Applicable
Quick Ship Part Number	1303231